

Makita[®]

SPARE PARTS

Ed. 11/2007

Model 448

Cod. 99 615B8B

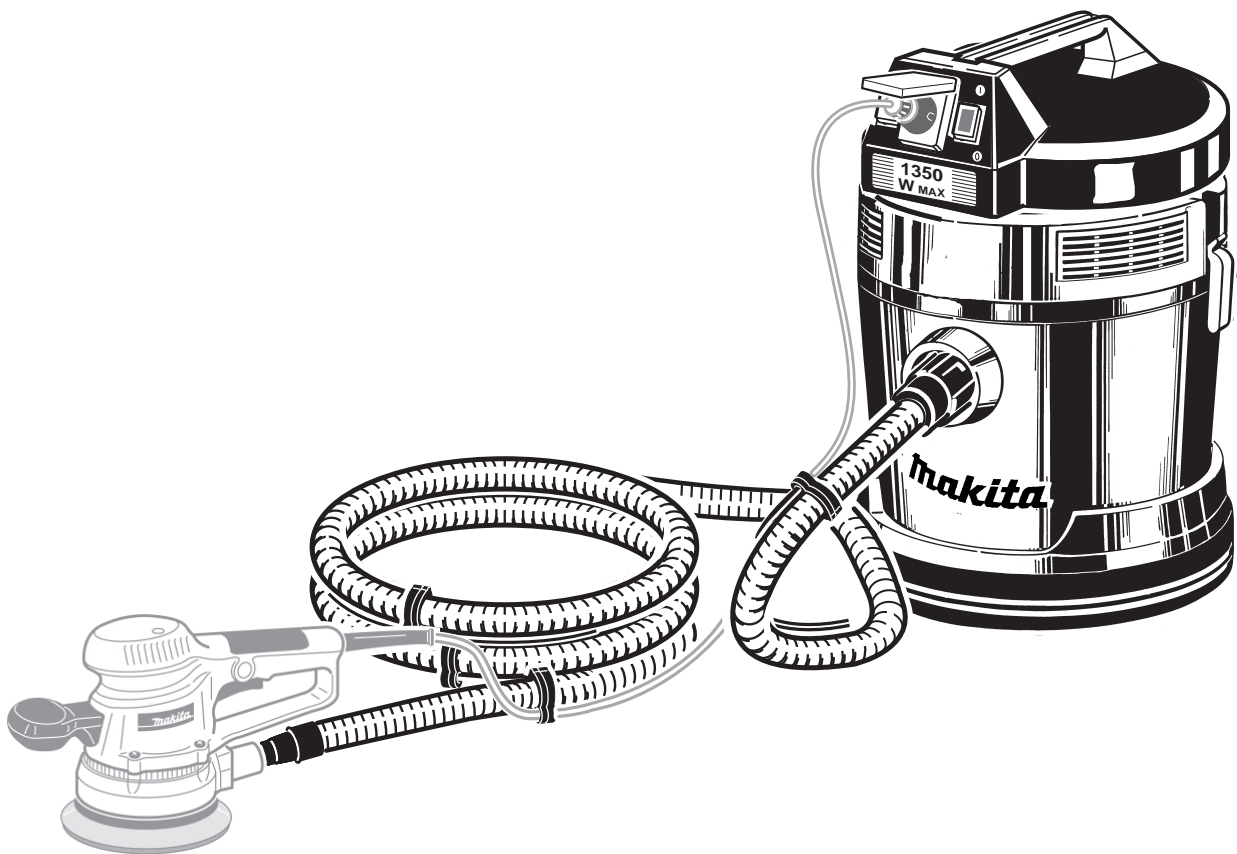

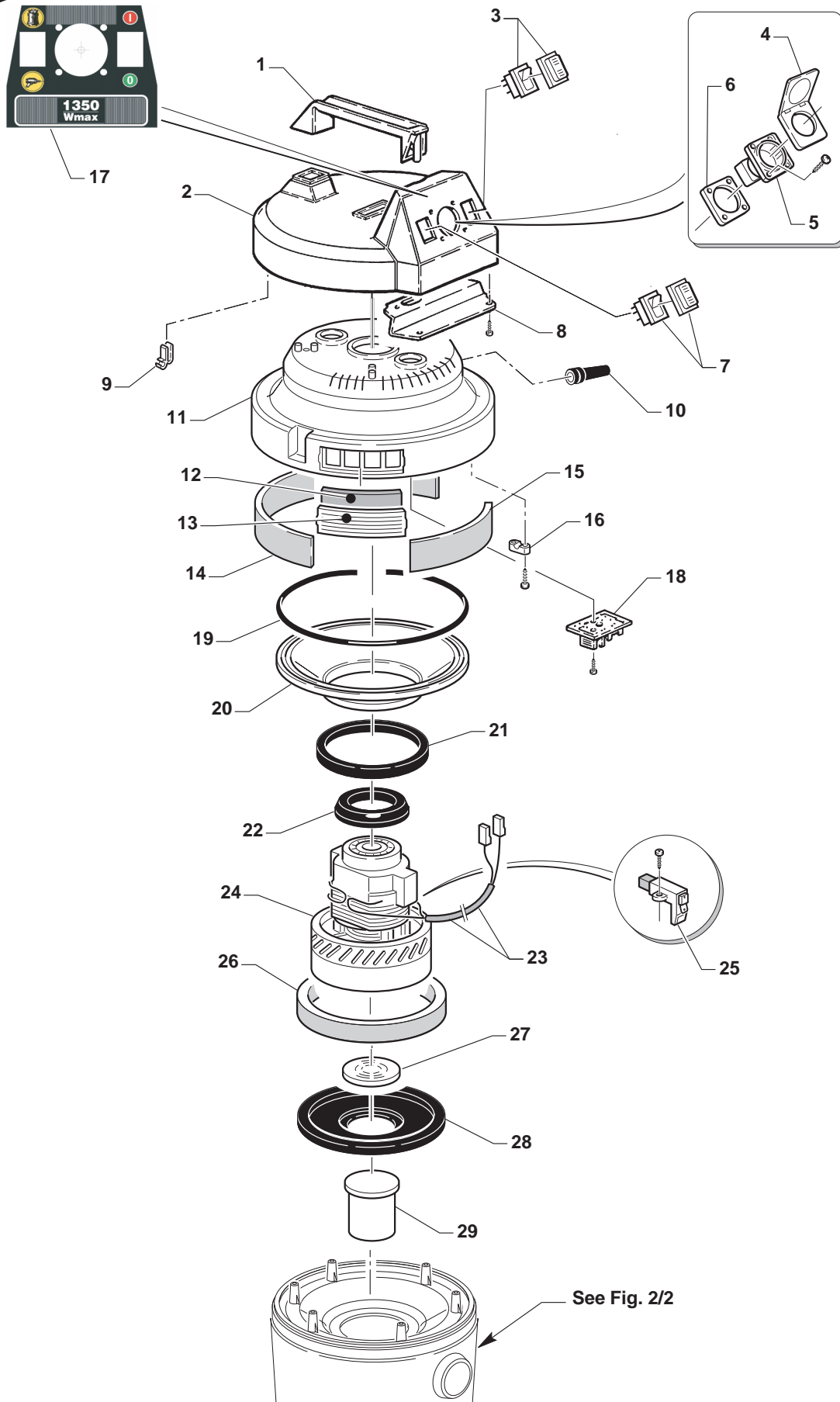

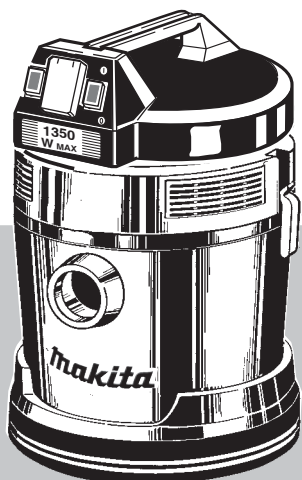

Model 448

Makita[®]

1/2

Pos.	Description	Code	Price € (Each)
01	Handle	50310B8B	
02	Cap	50305B8B	
03	Black bipolar switch	80041BDN	
04	Outer shell + cover	80202B8N	
05	Schuko socket	80200B8N	
06	Socket lock nut	50315BDV	
07	Unipolar switch	80042BDN	
08	Closing plate	50300BDV	
09	Cable fastener	50328BDN	
10	Cable guide	50330BDN	
11	Motor cover	50181B0A	
12	Filter grill	83021B8X	
13	Air outlet grill	50170B8A	
14	Cap long silencer	83022B8X	
15	Cap short silencer	83023B8X	
16	Cable fastener	50325BDN	
17	"MAKITA" adhesive 1350W	85644B8V	
18	Integrated electronic card	80209BDX	
19	Round P.V.C. ø 2,2 mm	70016B8N	
20	Diaphragm	50104B8V	
21	Diaphragm gasket	70055B0N	
22	Upper motor absorber	70060B8N	
23	Black PVC tube ø6x9 mm - L=110 mm	60235BHN	
24	1000W motor	20045B0X	
25	Brush holder insert	80051B5X	
26	Silencer ring	83020B8X	
27	Protection grill	50183B0V	
28	Support motor seal	70032B0N	
29	Float	50078B0V	
	> > > 2/2		

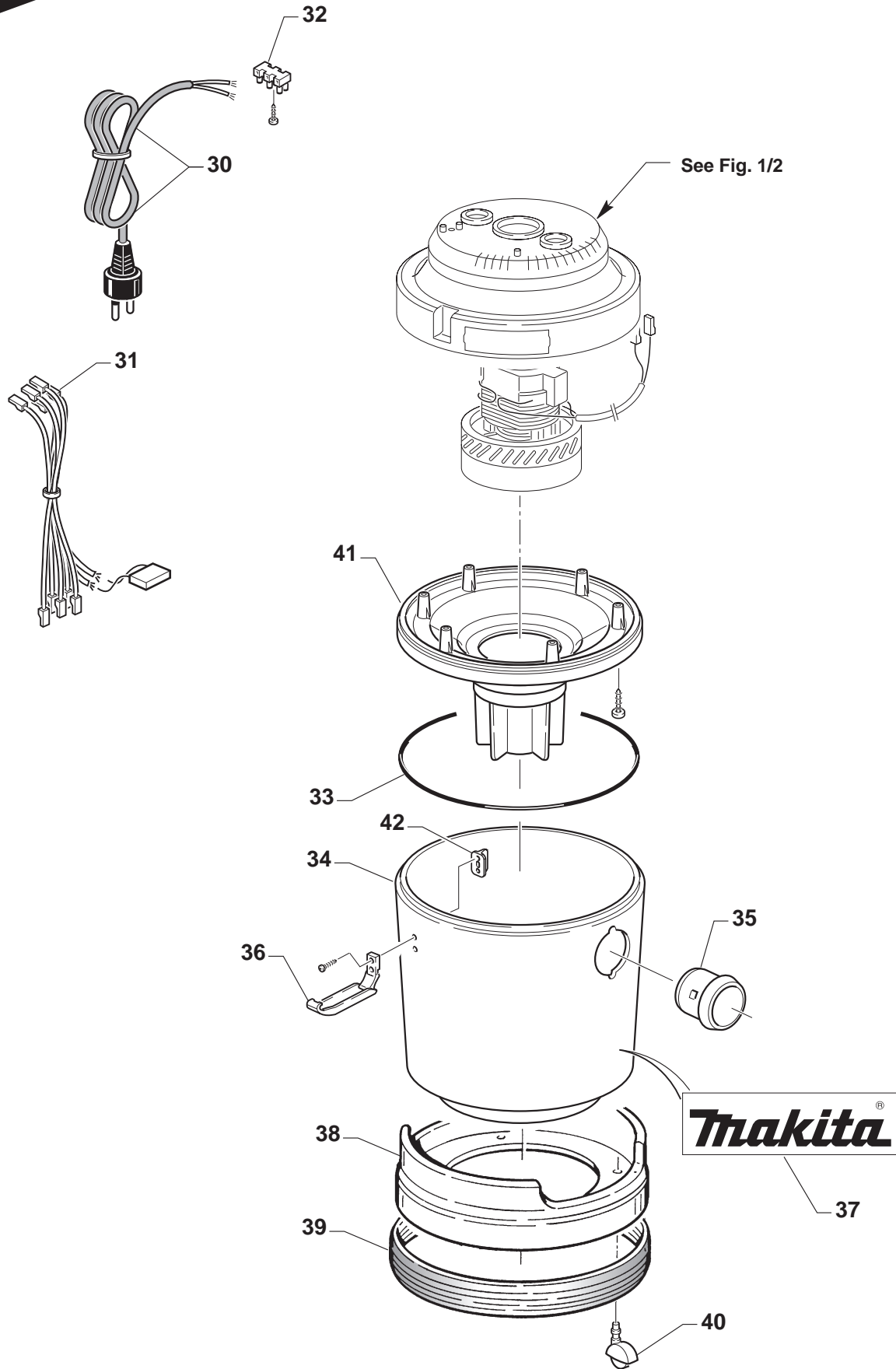

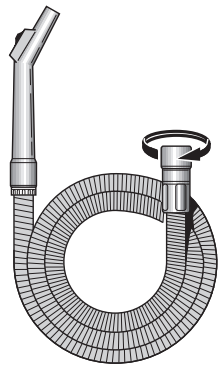
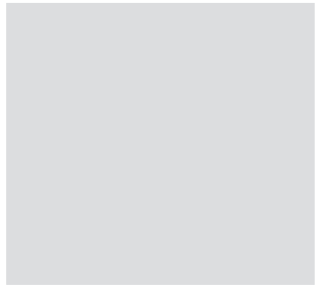

A1

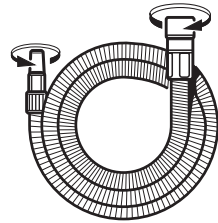

A2

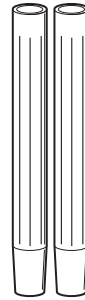

A3



A4



A5

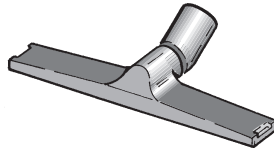

A6

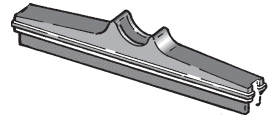

A7

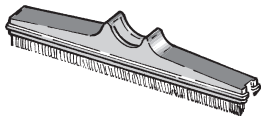

A8



A9

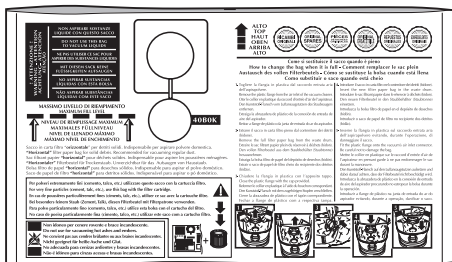
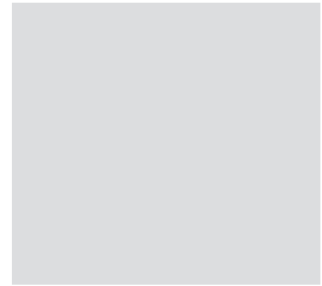
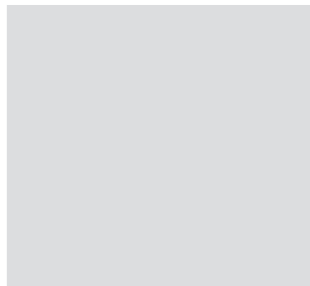

A10

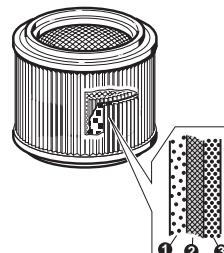

A11

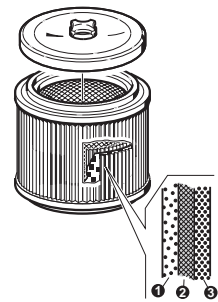

A12

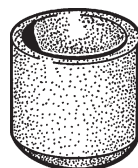
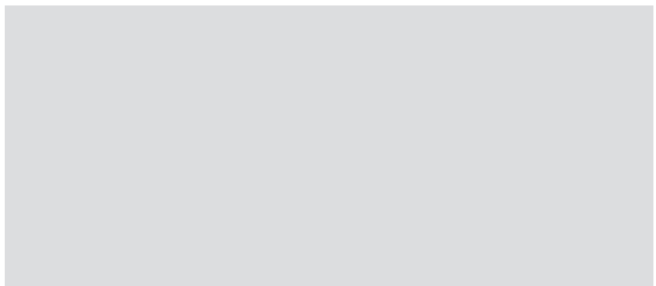

A13

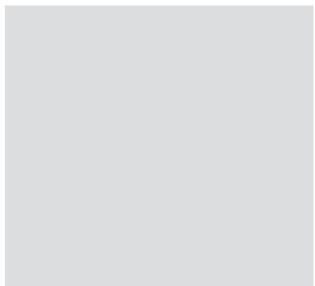

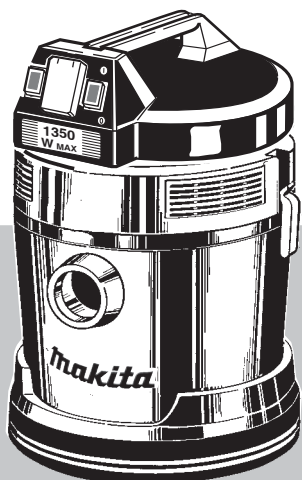

Model 448

Makita[®]

Accessories ø 45 mm

Pos.	Description	Code	Price € (Each)
A1	Flexible tube for extraction washing 2.5 mt.	01316B0N	
A2	Flexible tube for for electrical tools with universal adapter - mt. 2,8	01321B0N	
A3	Rigid extention ø 45	50091B0N	
A4	Crevice nozzle ø 45	50080B0N	
A5	Waste nozzle ø 45	50089B0N	
A6	Multiuse brush ø 45	60277B0N	
A7	Black A.B.S. wett nozzle	60278B0N	
A8	Black A.B.S. dust insert	60279B0N	
A9	Cable clamp for electric tool	50318BHN	
?	A10 Package of horizontal filter paper bag	83140B0K	
?	A11 Package of three stage filter cartridge	83200BDG	
?	A12 Package of three stage filter cartridge + adapter disk ...	83201BDG	
	A13 Foam filter	83035BHB	

Electrical diagram

Legenda colore cavi Cable colour coding

W	Bianco / White
Bk	Nero / Black
R	Rosso / Red
Br	Marrone / Brown
Bl	Blu / Blue
Gr	Verde / Green
Y	Giallo / Yellow

* - con faston - with faston

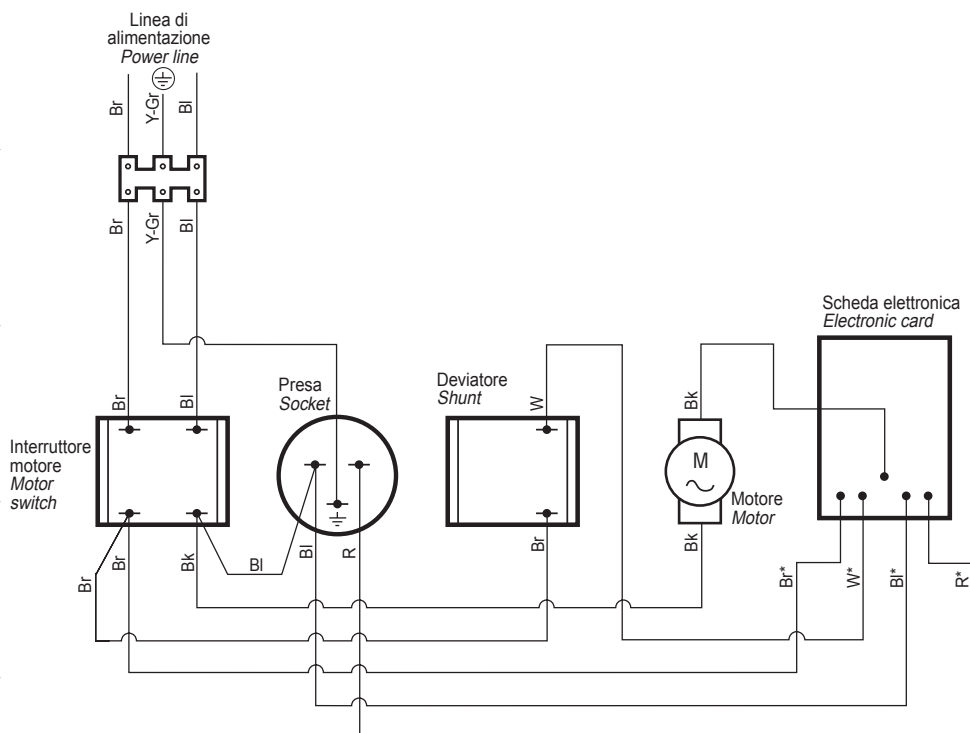

? Pack code

Makita®